



FULL LINE RTV ACCESSORIES & IMPLEMENTS

RTV400/RTV500 | RTV-XG850 SIDEKICK | RTV-X900/RTV-X1120/RTV-X1100C/RTV-X1140



WE ARE KUBOTA.

KUBOTA PERFORMANCE & ENGINEERING TESTED

As industry leaders, we have a long list of "number ones" to our credit, which is founded upon decades of precision quality, and unbroken trust.



#1 GLOBAL LEADER IN COMPACT EXCAVATORS

OEM Off-Highway Researched, 2016



#1 DIESEL ENGINE MANUFACTURER

Largest builder of Under 100 hp Multi-Cylinder,
Non-Automotive Diesel Engines



#1 SUB-COMPACT TRACTOR

AEM/EDA Industry Data May 2016



#1 DIESEL UTILITY VEHICLE

Kubota is the best-selling diesel utility vehicle manufacturer in North America since 2004*. And with 1,102 lb cargo capacity and 1,300 lb towing capacity, the RTV-X Series has the power and dependable performance to handle whatever job you may throw at it. Plus, we've developed an advanced experience in drivability and ergonomics, so your ride will be comfortable and smooth even in the roughest work environments.

*Power Products marketing. North American Utility Vehicle Markets Report May 2016



Don't settle for less.
KEEP IT KUBOTA!

TABLE OF CONTENTS

KUBOTA RTV LINEUP



RTV400Ci



RTV500



RTV-XG850
SIDEKICK



RTV-X900



RTV-X1120



RTV-X1140



RTV-X1100C

MID-SIZE UTILITY VEHICLES

RTV400/RTV500 Accessories & Implements

Cab Components	4
Winches / Guard / Bed Lift	8
Cab Accessories	9
Storage / Lights	10
Snow Removal / Tires & Wheels	11

FULL-SIZE UTILITY VEHICLES

RTV-XG850 SIDEKICK Accessories & Implements

Cab Components	12
Lights / Harnesses	14
Lights / Cab Accessories	15
Winches / Bed Lift	16
Guards	17
Cargo / Storage	18
Snow Removal / Tires & Wheels	19

RTV-X SERIES Accessories & Implements

Cab Components	20
Winches / Bed Lift / Hitch	24
Guards	25
Cargo / Storage	26
Cab Accessories	27
Rapid Access Cargo (RAC System)	28
Lights / Harnesses	30
Lights / Engine	31
Snow Removal	32
Snow Removal: K-Connect	34
Spreaders	38
Tires & Wheels	40
RTV Accessories	41



A Poly Cab Enclosure

77700-V4409 (V4409)

RTV-400

Poly cab enclosure bundled all together to keep the operator and passenger out of the elements

Includes:

- Hard Cab Component Mounting Kit (77700-V4310A)
- Poly Windshield (77700-V4368)
- Plastic Canopy (77700-V4312)
- Acrylic Rear Panel (77700-V4428)
- Plastic Door Kit (77700-V4429)

Poly Cab Component Mounting Kit

7700-V4310A (V4310A)

RTV-400, RTV-500

- Slotted design mounting kit for quicker installation
- Included with Hard Cab Enclosure (77700-V4409)
- Only one mounting kit required to install the Hard Cab Enclosure (77700-V4409) components in any combination

The following 4 Cab Components are available as part of the 77700-V4409, and can also be purchased individually.

B

Poly Windshield

77700-V4368 (V4368)

RTV-400, RTV-500

- Steel framed hard coated poly windshield featuring 30X more scratch resistance than the typical acrylic windshields
- Superior scratch resistance for longer lasting glare-free optics
- Recommend adding Wiper Kit (77700-V4367)
- Requires Hard Cab Component Mounting Kit (77700-V4310A)

**C**

Plastic Canopy

77700-V4312 (V4312)

RTV-400, RTV-500

- Steel reinforced plastic canopy to keep the operator and passenger out of the elements
- Requires Hard Cab Component Mounting Kit (77700-V4310A)

**D**

Acrylic Rear Panel

77700-V4428 (V4428)

RTV-400, RTV-500

- Steel framed acrylic rear panel to prevent wind, dust, and rain from entering into the operator's area
- Requires Hard Cab Component Mounting Kit (77700-V4310A)

E

Plastic Door Kit

77700-V4429 (V4429)

RTV-400

- Steel reinforced black plastic doors and sliding acrylic side windows
- Requires Hard Cab Component Mounting Kit (77700-V4310A)

**F**

Wiper Kit

77700-V4367 (V4367)

RTV-400, RTV-500

- Keep mud, rain, dust, and everyday grime off the front windshield
- Compatible with Poly Windshield (77700-V4368) and (77700-V4365), Hard Cab Enclosure (77700-V4409), and Soft Cab Enclosure (77700-V4430)
- Not compatible with Upper Glass Windshield (K7311-99280)



A Vinyl Cab Enclosure

77700-V4430 (V4430)

RTV-400

Vinyl cab enclosure bundled all together to keep the operator and passenger out of the elements

Includes:

- Soft Cab Component Mounting Kit (77700-V4363)
- Poly Windshield (77700-V4365)
- Metal Canopy (77700-V4364)
- Vinyl Rear Panel*
- Vinyl Door Set*

*Not available separately

Vinyl Cab Component Mounting Kit

77700-V4363 (V4363)

RTV-400, RTV-500

- Required to install Poly Windshield (77700-V4365) or Metal Canopy (77700-V4364)



The following 2 Cab Components are available as part of the 77700-V4430, and can also be purchased individually.

B Poly Windshield

77700-V4365 (V4365)

RTV-400, RTV-500

- Steel framed hard coated poly windshield featuring 30X more scratch resistance than the typical acrylic windshields
- Superior scratch resistance for longer lasting glare-free optics
- Recommend adding Wiper Kit (77700-V4367)
- Requires Soft Cab Component Mounting Kit (77700-V4363)



C Metal Canopy

77700-V4364 (V4364)

RTV-400, RTV-500

- Metal canopy to keep the operator and passenger out of the elements
- 7 gauge steel
- Requires Soft Cab Component Mounting Kit (77700-V4363)



The following 4 Cab Components are not compatible with Cab Enclosure Systems.

**A1**

Upper Glass Windshield

K7311-99280 (V4316)

RTV-400, RTV-500

- Upper glass windshield to provide an upper front barrier from wind, dust, and rain
- Recommend adding Lower Poly Windshield (K7311-99290) for complete full coverage

**B1**

Lower Poly Windshield

K7311-99290 (V4315)

RTV-400, RTV-500

- Lower Poly windshield to provide a lower front barrier from wind, dust, and rain
- Folds up to allow access to the bonnet
- Recommend adding Upper Glass Windshield (K7311-99280) for complete full coverage

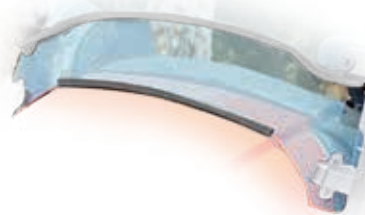
**C1**

Plastic Canopy

K7311-99390 (V4321)

RTV-400, RTV-500

- Plastic canopy to keep the operator and passenger out of the elements



Rear Cargo Screen

Gray K7311-99540 (V4350)

Black K7311-99590

RTV-400, RTV-500

- Rear net mounts directly to the ROPS and prevents objects from entering the operator area from behind
- Required to install Headrest Stay Kit (Gray - K7311-99530) or (Black - K7311-99580)

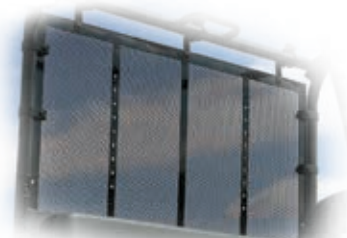

Warn VRX Winch Kit 3,500 lb. Steel Cable 77700-11552 RTV-400, RTV-500

NEW

- IP68 waterproofing system standard
- Redesigned & improved brake system
- Improved and redesigned clutch system
- Engineered system which outperforms the competition
- Limited lifetime mechanical & 3 year electrical warranty
- **Fits 2-seater units only**



Heavy Duty Winch - 2,500 lb. 77700-V4380 (V4380) RTV-400, RTV-500

- Three stage planetary gear train with sealed motor and switching systems
- Ergonomic Freespool - easy to engage and disengage
- Rugged all steel gears & bushings provide more torque and longer life
- Steel drum design
- Requires Front Winch Mount Kit (K7311-97312)



Silver Front Grill Guard K7311-99210 (V4325) RTV-500

- Upgrade the visual appearance while guarding the front with a heavy duty grill guard



2" Trailer Hitch Ball Mount 77700-V4349 (V4349) RTV-500

- SAE Class II approved
- Max Tongue/Towing 350/3500 lbs
- Glass black finish
- Trailer ball not included



Electric Bed Lift 77700-V4326 (V4326) RTV-400, RTV-500

- Convert a manual bed lift to an electric bed lift



CAB ACCESSORIES

Backup Beeper

K7211-99640 (V4336)

RTV-400

K7311-99640 (V4332)

RTV-500

- Alert the surrounding people when operating in reverse



Speedometer

K7211-99650 (V4338)

RTV-400

K7311-99650 (V4333)

RTV-500

- Displays the speeds up to 30 mph (50 km/h)



Headrest

K7501-99550 (V4231XT)

RTV-400, RTV-500

- Provides head support
- Sold individually
- Requires Headrest Stay Kit (Gray - K7311-99530) or (Black - K7311-99580)



Headrest Stay Kit

Gray K7311-99530 (V4341)

Black K7311-99580 (V4341A)

RTV-400, RTV-500

- Sold individually
- Required to install Headrest (K7501-99550)

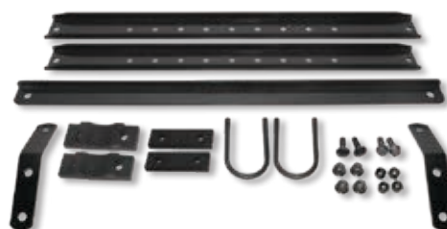

Side Mirror

ROPS 77700-V4358 (V4338)

RTV-400, RTV-500

CAB 77700-V5059 (V5059)

RTV-400

- Increases operator visibility
- Shatter resistant tempered convex mirror with a impact resistant housing
- Sold individually



Front Accessory Box

K7311-99560 (V4335)

RTV-400, RTV-500

- Mounts under the hood to hold small items securely



Cargo Box Mat

K7211-99200 (V4352)

RTV-400

K7311-99200 (V4351)

RTV-500

- Durable, polyurethane cargo box pad designed to protect all types of cargo



RTV Storage Cover

77700-V4381 (V4381)

RTV-400, RTV-500

- Keep the dust and debris off the machine
- Gray polyester fabric with two top corner vents
- Elastic skirting helps secure the cover to the machine



ROPS Storage Organizer

77700-V4384 (V4384)

RTV-400, RTV-500

- Nine protective storage pockets
- Heavy-duty padded design
- Easily attaches to the ROPS



Front/Rear Worklight Kit

77700-V4339 (V4339)

RTV-400, RTV-500

- Worklights can be used to light the front or rear of the machine
- Requires Plastic Canopy (77700-V4312) or Hard Cab Enclosure (77700-V4409)

Front Worklight Kit

K7311-99620 (V4322A)

RTV-400, RTV-500

- Halogen 27 watt output
- Includes wiring and mounting hardware
- Compatible with Plastic Canopy (K7311-99390) or ROPS
- Not compatible with Plastic Canopy (77700-V4312) or Hard Cab Enclosure (77700-V4409)
- Sold in a pair (left & right)

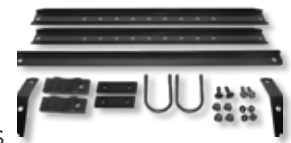

Rear Worklight Kit

K7311-99630 (V4323A)

RTV-400, RTV-500

- Halogen 27 watt output
- Includes wiring and mounting hardware
- Compatible with Plastic Canopy (K7311-99390) or ROPS
- Not compatible with Plastic Canopy (77700-V4312) or Hard Cab Enclosure (77700-V4409)
- Sold individually



Strobe Light Kit

77700-V4318 (V4318)

RTV-400, RTV-500

- Strobe light with rubber base and polycarbonate lens
- On/off toggle switch included
- Not compatible with Plastic Canopy (K7311-99390)
- Requires Plastic Canopy (77700-V4312) or Hard Cab Enclosure (77700-V4409)



Turn Signal/Hazard Light Kit

K7311-99610 (V4337A)

RTV-400, RTV-500

- Includes two front hazard/indicator lamps and two rear combination hazard/indicator/tail lamp assemblies
- Not compatible with Poly Windshield (77700-V4368) or Hard Cab Enclosure (77700-V4409)



SNOW REMOVAL / TIRES & WHEELS

60" Front Blade

V4308A*

RTV-400, RTV-500

- 60" wide (straight) snow blade with trip spring
- 52" plow width @ 30° max angle
- Electric lift with manual angle adjustment
- Includes adjustable skid shoes and dedicated hitch
- Not compatible with 2" Trailer Hitch Ball Mount (77700-V4349)

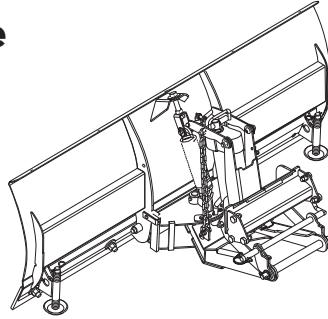

Snow Deflector

V4307*

RTV-400, RTV-500

- Rubber deflector mounted to the top of the 60" Front Blade (V4308A) to reduce the throw of snow and debris from the front blade
- Requires 60" Front Blade (V4308A)

Heavy Duty Cutting Edge

V4306*

RTV-400, RTV-500

- Upgraded cutting edge constructed of heavy duty mild carbon steel
- Cutting edge is reversible for extended wear
- Requires 60" Front Blade (V4308A)

Standard Cutting Edge

V4305*

RTV-400, RTV-500

- Replacement standard cutting edge which is standard on 60" Front Blade (V4308A)
- Cutting edge is reversible for extended wear
- Requires 60" Front Blade (V4308A)

HDWS Tire & Wheel Assembly

Front K7311-19310 (ARTV4303)

Rear K7311-19410 (ARTV4304)

RTV-400, RTV-500

- Includes 1 OEM tire and steel wheel
- Front - 24x9-12 6-ply tire
- Rear - 24x11-12 6-ply tire
- HDWS tread design are non-directional



ATV Tire & Wheel Assembly

Front Left K7311-19110 (ARTV4301)

Front Right K7311-19160 (ARTV4301)

Rear Left K7311-19210 (ARTV4302)

Rear Right K7311-19260 (ARTV4302)

RTV-400, RTV-500

- Includes 1 OEM tire and steel wheel
- Front - 24x9-12 6-ply tire
- Rear - 24x11-12 6-ply tire
- ATV tread design are directional (left or right)



RTV-XG850 SIDEKICK

Poly Windshield

77700-VP0804A

- Fixed hard coated poly windshield to provide a front barrier from wind, dust, and rain
- Includes 4 quick clamps preinstalled for a quick and easy install

Poly Flip Windshield

77700-VP0805

- Flip hard coated poly windshield to provide a front barrier from wind, dust, and rain
- Includes 4 quick clamps preinstalled for a quick and easy install

Glass Windshield

77700-VP0802

- Fixed laminated glass windshield to provide a front barrier from wind, dust, and rain
- Includes 4 quick clamps preinstalled for a quick and easy install
- Recommend adding Wiper Kit (77700-VP0817) and Washer Kit (77700-VP0818)

Premium Roof

77700-VP0801A

- Twin sheet vacuum formed black plastic roof with plug & play connections for electrical accessories and Premium Audio System (77700-09070)
- Keep the operator and passenger out of the elements

Premium Audio System

77700-09070

- Rugged Jensen Bluetooth audio system offers AM/FM, USB, and Auxiliary inputs
- Includes two Jensen speakers & antenna
- Not compatible with the Sport Roof (77700-VP0800)
- Requires Accessories Wiring Harness (77700-V0881)

Sport Roof

77700-VP0800

- Single sheet vacuum formed black plastic roof
- Keep the operator and passenger out of the elements

Sport Roof Seal Panel Kit

77700-VP0807

- Not compatible with Premium Roof (77700-VP0801A)
- Required when using Heater Kit (77700-V5247) to create a fully sealed cab

Premium Roof

Premium Audio System

Sport Roof

Sport Roof Seal Panel Kit

Poly Windshield

Poly Flip Windshield

Glass Windshield



Wiper Kit

77700-VP0817

- Includes a single wiper to keep the glass windshield clear from dust and rain
- Compatible only with Glass Windshield (77700-VP0802)
- Requires Accessory Wiring Harness (77700-V0881)

Washer Kit

77700-VP0818

- Upgrade the wiper kit with a washer kit to help keep the glass windshield clear
- Compatible only with Glass Windshield (77700-VP0802)
- Requires Wiper Kit (77700-VP0817) and Accessory Wiring Harness (77700-V0881)

Antenna

K7711-63160

- Optional antenna for the Premium Audio System (77700-09070) for AM/FM

Poly Rear Panel

77700-VP0806

- Poly rear panel to prevent wind, dust, and rain from entering into the operator's area
- Features a louver vent to allow airflow through the cabin

Glass Rear Panel

77700-VP0803

- Glass rear panel to prevent wind, dust, and rain from entering into the operator's area

Side Mirror Kit

Cab 77700-VP0815

ROPS 77700-V4358

- Increases operator visibility
- Cab mirrors sold in a pair (left & right)
- ROPS mirror sold individually

Underhood Seal Kit

77700-VP0808

- Required when using Heater Kit (77700-V5247) to create a fully sealed cab

Heater Kit

77700-V5247

- Add an integrated heater with an in-dash adjustable temperature
- Requires an Underhood Seal Kit (77700-VP0808) for a fully sealed cab
- Requires a Sport Roof Seal Panel Kit (77700-VP0807) when used with a Sport Roof (77700-VP0800)

Front Heavy Duty Strut Kit

K7591-99180 (V5219)

- A pair of preassembled front struts with heavy duty springs
- No special tools required to install
- Required when installing an enclosed cab or front implement

2" ROPS Quick Clamp

77700-VP0819A

- Quick and easy ROPS clamp to attach an assortment of RTV accessories
- Sold individually

Door Insert Kits

Orange 77700-VP0820

Camo 77700-VP0821

Green 77700-VP0822

Black 77700-VP0823

- Add matching accent door panels to match the body color of the hood and rear cargo bed panels

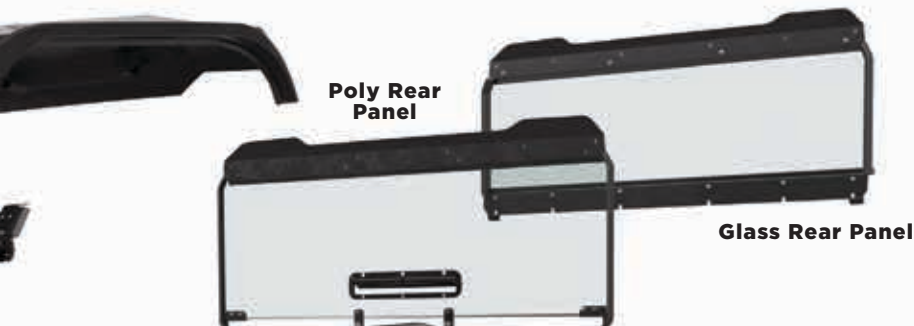

Poly Rear Panel

Glass Rear Panel



Door Set



Door Insert Kits

Door Set

77700-VP0810

- Rear hinged thermoformed doors with steel frame for increased rigidity
- Large roll down glass windows
- Features a storage pocket with an integrated bottle holder
- Requires Front Heavy Duty Strut Kit (K7591-99180) when installing an enclosed cab or front implement

Switches for the lighting accessories below are included with their respective mounting kit.

6" LED Worklight

77700-VP0892

- Equipped with 6 LEDs and produces 1,000 lumens
- Features a quick connector for an easy front or rear worklight install
- Sold individually
- Requires Front Worklight Mounting Kit (77700-VP0893) or Rear Worklight Mounting Kit (77700-VP0894)
- Requires Sport Roof Worklight Supports (77700-V0890) when used with a Sport Roof (77700-VP0800)
- Requires two 2" ROPS Quick Clamps (77700-VP0819A) when installing 2 worklights onto the ROPS



13.5" LED Light Bar

77700-VP0891

- Features a low and high setting equipped with 12 LEDs capable of producing 2,200 lumens (High setting)
- Requires Light Bar Mounting Kit (77700-VP0895)
- Requires two 2" ROPS Quick Clamps (77700-VP0819A) when installed onto the ROPS

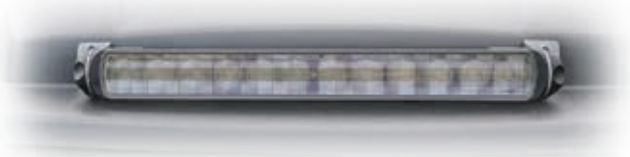

Rotating Beacon

77700-08687

- Features a magnetic base
- 195 flashes per minute
- Requires Strobe Mounting Kit (77700-VP0896) and Accessory Wiring Harness (77700-V0881)
- Requires one 2" ROPS Quick Clamps (77700-VP0819A) when installed onto the ROPS



Strobe Light

77700-08686

- LED strobe light features a magnetic base
- 70 flashes per minute
- 11 flash patterns
- Requires Strobe Mounting Kit (77700-VP0896) and Accessory Wiring Harness (77700-V0881)
- Requires one 2" ROPS Quick Clamps (77700-VP0819A) when installed onto the ROPS



Powering any of the 4 lights above will require a switch panel and accessory wiring harness. Add a ROPS wiring harness to add plug & play connections to a ROPS or Sport Roof configuration.

Switch Panel

77700-V0880

- Centralize accessory switches into one convenient location
- Required for 13.5" LED Light Bar (77700-VP0891), 6" LED Worklights (77700-VP0892), Strobe Light (77700-08686) or Rotating Beacon (77700-08687), Wiper Kit (77700-VP0817), and Washer Kit (77700-VP0818)

Accessory Wiring Harness

77700-V0881

- Main harness to provide power to the Premium Roof (77700-VP0801A) or ROPS Wiring Harness (77700-V0882)
- Includes plug & play connections for a rear 6" LED Worklight (77700-VP0892), Strobe Light (77700-08686) or Rotating Beacon (77700-08687), Wiper Kit (77700-VP0817), and Washer Kit (77700-VP0818)

ROPS Wiring Harness

77700-V0882

- Includes plug & play connections for 13.5" LED Light Bar (77700-VP0891) and two front 6" LED Worklights (77700-VP0892)
- Requires Accessory Wiring Harness (77700-V0881)

LIGHTS / CAB ACCESSORIES

Need more lights? Check out these additional lighting kits, which includes everything necessary to light the way to cross over to more.

LED Headlight

K7811-99680

- Add an optional 2nd set LED headlight to give the machine that unique quad LED look



Front Worklight Kit

K7811-99650

- Add optional front worklights to the Sidekick front guard
- Sold in a pair (left & right)
- Requires Sidekick Front Guard (K7811-97200)



Turn Signal / Hazard Light Kit

K7811-99610

- Includes two front hazard/indicator lamps and two rear combination hazard/indicator/tail lamp assemblies



Reverse Alarm

K7811-99640

- Alert the surrounding people when operating in reverse



Interior Rearview Mirror

77700-VP0816

- Convex wide mirror and mounts to the ROPS
- Easy to install on a ROPS or Cab



Headrest

K7811-99550

- Provides extra head support with a stylish design
- Sold individually
- Requires Headrest Stay Kit K7591-99540 (V5230A)



Headrest Stay Kit

K7591-99540 (V5230A)

- Sold individually
- Required to install Headrest (K7811-99550)



Soft Grip Handle

77700-V0834

- Steel handle wrapped with a rubber grip
- Kubota branded heavy duty Velcro strap
- Easy to install and remove





Warn VRX & Axon Winches

Winch Kit VRX 3,500 lb. Steel Cable 77700-11552

Winch Kit VRX 4,500 lb. Synthetic Rope 77700-11554

Winch Kit AXON 3,500 lb. Steel Cable 77700-11556

Winch Kit AXON 4,500 lb. Synthetic Rope 77700-11558

- IP68 waterproofing system standard
- Redesigned & improved brake system
- Improved and redesigned clutch system
- Engineered system which outperforms the competition
- The Axon line features class-leading electronics for better winch control & half the installation time compared to the VRX
- Limited lifetime mechanical & 3 year electrical warranty
- **Fits 2-seater units only**

NEW



Electric Over Hydraulic Bed Lift

K7811-99670

- Convert a manual bed lift to an electric over hydraulic bed lift



GUARDS

Plastic Bumper

K7811-99220

- Upgrade the visual appearance of the front bumper



Tail Lamp Guard

K7811-99660

- Upgrade the visual appearance while protecting the tail lamps
- Sold in a pair (left & right)



Sidekick Front Guard

K7811-97200

- Replacement RTV-XG850 Sidekick front guard
- Upgrade the front appearance of a General Purpose



Rear Bumper

K7811-99250

- Upgrade the visual appearance while guarding the cargo bed
- Includes Tail Lamp Guards (K7811-99660)



Front Under Guard

K7811-99240

- Upgrade the visual appearance while guarding the front underside



A-Arm Guard

Front K7811-99150

Rear K7811-99160

- Metal guards to guard against debris
- Sold in a pair (left & right)



Bush Guard

K7811-99230

- Upgrade the visual appearance while guarding the front

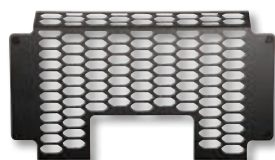

Mud Guard

Front K7591-99520 (V5225)

Rear K7811-99510

- Add a visual appeal while guarding against debris
- Sold in a pair (left & right)



Deluxe RTV Cargo Box

77700-08760

- Features 4.5 cu. ft. of cargo capacity in a tough and durable polyethylene construction to resist corrosion, water, and dust
- Lockable latches to secure your cargo
- Transport your tools and equipment into some of the most extreme terrain and conditions
- Easy-to-lift covers providing easy access from either side of the box
- Sliding and removable tool trays for better organization
- Great for outdoors men - non-reflective surfaces
- Requires 2 pairs of Cargo Clamps (K7811-99560) and Plastic Cargo Box Mounting Kit (77700-V0838)
- Requires 2 additional Plastic Cargo Box Mounting Kits (77700-V0838) when installed with RTV Rubber Cargo Bed Mat (77700-V0830)



Cargo Clamp

K7811-99560

- Drill-less cargo bed clamp with interchangeable rubber inserts
- Sold in a pair



Bed Extender

K7811-99570

- Drill-less design and can be positioned along the length of the cargo bed
- Can be positioned to extend or divide the cargo bed capacity



Cargo Bed Rail

K7811-99590

- Increase cargo bed capacity
- Sold in a pair (left & right)
- Not compatible with Deluxe RTV Cargo Box (77700-08760)



Rack Over Hood

77700-V0831

- Mounts to the front guard to add additional storage over the front hood
- Designed to be removed quickly without tools
- Can be pivoted to access the components under the front hood for general service and maintenance
- Not compatible with Plastic Bumper (K7811-99220)



RTV Rubber Cargo Bed Mat

77700-V0830

- Rubber compression molded rubber with integrated Kubota branding
- Protects the cargo bed from scratches and scuff marks
- Prevent objects from sliding around the cargo bed



SNOW REMOVAL / TIRES & WHEELS

72" General Duty Front Blade V5008*

- 72" wide general purpose snow blade with 19" moldboard height and 12 gauge moldboard thickness
- 64.5" plow width @ 30° max angle
- Electric lift with manual angle adjustment
- Requires Front Heavy Duty Strut Kit (K7591-99180) and General Purpose Front Guard (Black - K7591-97900)



Tire & Alloy Wheel Assembly

Green ATV Left K7811-99850

Green ATV Right K7811-99860

Green HDWS K7811-99800

Black ATV Left K7591-99850 (ARTV5212L)

Black ATV Right K7591-99860 (ARTV5212R)

Black HDWS K7591-99800 (ARTV5214)

Silver ATV Left K7591-99830 (ARTV5211L)

Silver ATV Right K7591-99840 (ARTV5211R)

Silver HDWS K7591-99790 (ARTV5213)

- Includes 1 OEM tire and alloy wheel
- 25x10-12 6-ply tire
- ATV tread design are directional (left or right)
- HDWS tread design are non-directional
- Requires alloy Wheel Hardware Kit (black - K7591-99140) or (silver - K7591-99170)



HDWS Tire & Wheel Assembly

K7811-19410

- Includes 1 OEM tire and steel wheel
- 25x10-12 6 ply tire
- HDWS tread design are non-directional



ATV Tire & Wheel Assembly

Left K7811-19210

Right K7811-19260

- Includes 1 OEM tire and steel wheel
- 25x10-12 6 ply tire
- ATV tread design are directional (left or right)



RTV-X SERIES

A1

Poly Windshield

77700-VC5023 (VC5023)
X900, X1120, X1140

- Steel framed, hard coated poly windshield to provide a front barrier from wind, dust, and rain
- Features latches to allow airflow through the cabin
- Compatible with Wiper Kit (77700-VC5030)

A2

Laminated Glass Windshield (AS1)

77700-VC5020 (VC5020)
X900, X1120, X1140

- Steel framed, laminated glass windshield to provide a front barrier from wind, dust, and rain
- Designed to hold together when shattered and prevents glass from breaking into large sharp pieces
- Features latches to allow airflow through the cabin
- Compatible with Wiper Kit (77700-VC5030)

A3

Tempered Glass Windshield (AS2)

77700-VC5025 (VC5025)
X900, X1140

- Steel framed, tempered glass windshield to provide a front barrier from wind, dust, and rain
- Designed to crumble into small granular chunks instead of sharp jagged shards
- Features latches to allow airflow through the cabin
- Compatible with Wiper Kit (77700-VC5030)

B

Wiper Kit

77700-VC5030 (VC5030)
X900, X1120, X1140

- Includes a single 16" wiper to keep glass & poly windshields clear from dust and rain
- Compatible only with Poly Windshield (77700-VC5023), Laminated Glass Windshield (77700-VC5020), & Tempered Glass Windshield (77700-VC5025)



Alternative windshields for a windshield & canopy configuration only.

Poly Windshield

Clear K7591-99290 (V5258)
Tinted K7591-99260 (V5259)
X900, X1120

- Alternative, crack resistant poly windshield for those who do not require the compatibility of a full cab enclosure
- Not compatible with Wiper Kit (77700-VC5030)
- Compatible only with Plastic Canopy (K7591-99390)



Acrylic Windshield

Clear 77700-V5027 (V5027)
Tinted 77700-V5028 (V5028)
X900, X1120, X1140

- Alternative, scratch resistant acrylic windshield for those who do not require the compatibility of a full cab enclosure
- Not compatible with Plastic Canopy (K7591-99390) & Wiper Kit (77700-VC5030)



**C1****Metal FOPS Canopy****Black** 77700-VC5000 (VC5000)**Orange** 77700-VC5001 (VC5001)**X900, X1120****Black** 77700-VC5044 (VC5044)**X1140**

- Metal canopies are FOPS certified to provide additional protection while keeping the operator and passenger out of the elements
- Not compatible with Poly Windshield (clear - K7591-99290) or (tinted - K7591-99260)

**C2****Plastic Canopy****Black** 77700-VC5011 (VC5011)**X900, X1120****Black** 77700-VC5043 (VC5043)**X1140**

- Plastic canopy to keep the operator and passenger out of the elements
- Not compatible with Poly Windshield (clear - K7591-99290) or (tinted - K7591-99260)



Alternative canopy for a windshield & canopy configuration only.

Black Plastic Canopy

K7591-99390 (V5221)

X900, X1120

- Alternative plastic canopy for those who do not require the compatibility of a full cab enclosure
- Compatible only with Poly Windshield (clear - K7591-99290) or (tinted - K7591-99260)

**D1****Glass Rear Panel**

77700-VC5040 (VC5040)

X900, X1120

- Steel framed, glass rear panel to prevent wind, dust, and rain from entering into the operator's area

**D2****Rear Screen****Gray** K7711-99280 (V4258)**Black** K7731-99280 (V4258A)**X1100**

- Optional rear screen mounts to the RTV-X1100's ROPS structure acting as a barrier between the bed and rear window



A



A1

Metal Door Set

Black 77700-VC5090 (VC5090)

Orange 77700-VC5091 (VC5091)

X900, X1120

- Steel doors featuring an upper sliding window and a lower pocket window
- Convenient heavy duty hinges allow for doors to be removed and stored away
- Requires Front Heavy Duty Strut Kit (K7591-99180) or Front Heavy Duty Spring Kit (K7591-99190)



A2

Vinyl Door Set

77700-VC5095 (VC5095)

X900, X1120

- Vinyl doors featuring clear vinyl window
- Windows can be zipped open and rolled up
- Convenient heavy duty hinges allow for doors to be removed and stored away
- Requires Front Heavy Duty Strut Kit (K7591-99180) or Front Heavy Duty Spring Kit (K7591-99190)



A3

4 Metal Door Set w/ Rear Panel

77700-VC5045 (VC5045)

X1140

- 4 steel doors featuring an upper sliding window and a lower pocket window
- Includes a rear panel to fully enclose the RTV-X1140 in a two row configuration when combined with a compatible canopy and windshield
- Convenient heavy duty hinges allow for doors to be removed and stored away
- Recommend adding a mid-panel to fully enclose the front row of the RTV-X1140 when combined with a compatible canopy and windshield



Mid-Panel

Steel w/ Sliding Window 77700-VC5046 (VC5046)

Vinyl 77700-VC5047 (VC5047)

X1140

- Add an optional mid-panel to completely enclose the front row of the RTV-X1140
- Requires 4 Metal Door Set with Rear Panel (77700-VC5045)



Steel with Sliding Window

Front Heavy Duty Spring Kit

K7591-99190 (V5218)

X900, X1120, (X1100 & X1140 - Standard)

- Reuse the front struts and upgrade the front springs to heavy duty springs
- Required when installing an enclosed cab and/or front implement

Front Heavy Duty Strut Kit

K7591-99180 (V5219)

X900, X1120, (X1100 & X1140 - Standard)

- A pair of preassembled front struts with heavy duty springs
- No special tools required to install
- Required when installing an enclosed cab and/or front implement

Heater Kit

77700-VC5083A (VC5083A)

X900, X1120, X1140

- Add an integrated cab heater with well-placed vents to stay warm during frigid winters
- Requires Wire Harness (Multiple - 77700-VC5080) or (Single - 77700-VC5081)



Side Mirror Kit

Cab 77700-VC5076 (VC5076)

ROPS 77700-V4358 (V4358)

X900, X1120, X1140

- Increases operator visibility
- Cab mirrors sold in a pair (left & right)
- ROPS mirror sold individually



Side Mirror

77700-V5059 (V5059)

X1100

- Shatter resistant tempered convex glass for increased durability
- Impact resistant ABS housing for lasting durability
- Ball socket joint provides easy adjustment and wide range view
- Sold individually



Sideview Mirror

77700-10706

**RTV-X900, RTV-X1120,
RTV-X1140, RTV-XG850**

- Huge field of view
- Universal mounting
- Dual axis breakaway
- Three-way adjustment
- Adjustable blindspot mirror
- Anti-vibration technology
- Fits 1.25" to 2" roll cages
- Fits left or right side
- Easily return mirror to your preset position each time it breaks away for consistent viewing alignment



Heavy Duty AM/FM/CD/USB/ WB/Bluetooth®/iPhone®/SiriusXM Ready®/App Ready Radio

77700-04755

X1100

- 180 watt max output (45W x 4)
- iPod/iPhone controls and charging via front USB
- SiriusXM Ready (requires SiriusXM tuner and antenna)
- Seven-channel NOAA weatherband tuner and "Weather Alert"
- Microphone sold separately



Heavy Duty AM/FM/WB Radio

77700-04753

X1100

- 160 watt max output (40W x 4)
- Seven-channel NOAA weatherband tuner
- Segmented, high-visibility LCD display with clock
- Two-wire hook-up prevents battery drain when vehicle is off



Heavy Duty AM/FM/WB/ USB/iPhone®/iPod®/SiriusXM Ready® Radio

77700-04754

X1100

- Same features as 77700-04755 with the exception of a CD player and Bluetooth





NEW



Warn VRX & Axon Winches

Winch Kits for 2-Seater Units:

VRX 3,500 lb. Steel Cable 77700-11552

VRX 4,500 lb. Synthetic Rope 77700-11554

AXON 3,500 lb. Steel Cable 77700-11556

AXON 4,500 lb. Synthetic Rope 77700-11558

X900, X1100, X1120

- IP68 waterproofing system standard
- Redesigned & improved brake system
- Improved and redesigned clutch system
- Engineered system which outperforms the competition
- The Axon line features class-leading electronics for better winch control & half the installation time compared to the VRX
- Limited lifetime mechanical & 3 year electrical warranty
- **4-Seater winches for RTV-X1140 only**

Winch Kits for 4-Seater Units:

VRX 3,500 lb. Steel Cable 77700-11553

VRX 4,500 lb. Synthetic Rope 77700-11555

AXON 3,500 lb. Steel Cable 77700-11557

AXON 4,500 lb. Synthetic Rope 77700-11559
X1140



Hydraulic Bed Lift

K7591-99320 (V5242)

**General Purpose X900,
General Purpose X1120,
(Worksite & Camo X900,
Worksite & Camo X1120,
X1100, and X1140 - Standard)**

- Upgrade a manual bed lift on a general purpose RTV-X900 or RTV-X1120 to hydraulic bed lift



2" Trailer Hitch Ball Mount

77700-V5200 (V5200)

X900, X1120, X1100, X1140

- Towing is easy with this 2" Trailer Ball Mount Kit (does not include hitch ball)



GUARDS

General Purpose Front Guard

Gray K7591-97200

X900

Black K7591-97900

X900, X1120

- Replacement general purpose front guard



Worksite Front Guard

Gray K7591-97210

X900

Black K7591-97910

X900, X1120, X1140

- Replacement worksite front guard



Deluxe Front Guard

Gray K7421-97200

X1120, X1100, X1140

Black K7421-97900

X1120, X1100, X1140

- Replacement deluxe front guard



Tail Lamp Guard Kit

K7591-99660 (V5227)

X900, X1120, X1100, X1140

- Protect your tail light from damaging debris by installing this Tail Lamp Guard Kit



CV Joint Guard

Front K7591-99150 (V5238)

Rear K7591-99160 (V5239)

X900, X1120, X1100, X1140

- Help protect your front CV Joint from rocks and stumps with this CV Joint Guard
- Reduce potential damage to the rear CV Joint with this CV Joint Guard

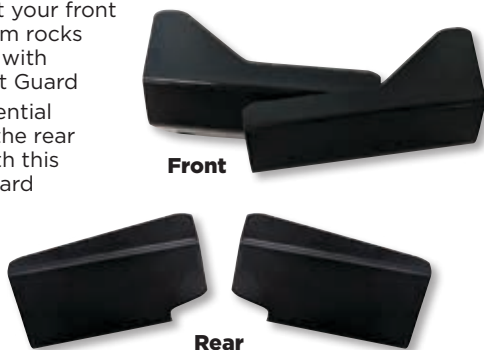

Mud Guard

Front K7591-99520 (V5225)

Rear K7591-99510 (V5226)

X900, X1120, X1100, X1140

- Cut down on flying mud by installing this Mud Guard Kit
- Decrease mud spatter off the rear wheels with this Mud Guard Kit



Deluxe RTV Cargo Box

77700-08760 (V0839)

X900, X1120, X1100, X1140

- Features 4.5 cu. ft. of cargo capacity in a tough and durable polyethylene construction to resist corrosion, water, and dust
- Lockable latches to secure your cargo
- Transport your tools and equipment into some of the most extreme terrain and conditions
- Easy-to-lift covers providing easy access from either side of the box
- Sliding and removable tool trays for better organization
- Great for outdoorsmen - non-reflective surfaces
- Requires 2 pairs of Cargo Clamps (K7811-99560) and Plastic Cargo Box Mounting Kit (77700-V0838)
- Requires 2 additional Plastic Cargo Box Mounting Kits (77700-V0838) when installed with RTV Rubber Cargo Bed Mat (77700-V0830)



2 Cargo Clamps

K7811-99560 (V0859)

X900, X1120, X1100, X1140

- Drill-less cargo bed clamp with interchangeable rubber inserts
- Sold in a pair



Plastic Bed Liner

K7591-99580 (V5229)

X900, X1120, X1100

- Prevent bed dents and dings with this high-quality plastic bed liner

RTV Storage Cover

77700-V4382 (V4382)

X900, X1120, X1100

77700-V4383 (V4383)

X1140

- All-season protection
- UV protection
- Elastic Bottom Hem



RTV Rubber Cargo Bed Mat

77700-V0830 (V0830)

X900, X1120, X1100

- Rubber compression molded rubber with integrated Kubota branding
- Protects the cargo bed from scratches and scuff marks
- Prevent objects from sliding around the cargo bed



CAB ACCESSORIES

Interior Rearview Mirror

77700-V4266 (V4266)

X900, X1120, X1140

- Mount an interior rearview mirror onto the ROPS for added visibility



Interior Rearview Mirror

77700-VP0816 (VP0816)

X900, X1120, X1140

- Convex wide mirror and mounts to the ROPS
- Easy to install on a ROPS or Cab



Sun Visor Kit

K7731-99270 (V5286)

X1110

- Match the interior of the RTV-X1100 with sun visors to block the sun
- Sold in a pair (left & right)



Glove Box Cover Kit

K7591-99570 (V5234)

General Purpose X900 & X1120, (Worksite & Camo X900, Worksite & Camo X1120, X1100, and X1140 - Standard)

- Upgrade the general purpose RTV-X900 & general purpose RTV-X1120 to a covered glove box to keep items away from the elements



Headrest

Gray K7501-99550 (V4231XT)

X900, (RTV-X1100 - Standard)

Black K7421-99550 (V5231)

X1120

- Add comfort and support to your day with this Headrest from Kubota
- Sold individually
- Requires Headrest Stay Kit (gray - K7591-99530) or (black -K7591-99540)



Headrest Bracket Kit

Gray K7591-99530 (V5230)

Black K7591-99540 (V5230A)

X900, X1120

- Required to install headrest (gray - K7501-99550) or (black - K7421-99550)
- Sold individually



Backup Alarm Kit

K7591-99640 (V5236)

X900, X1120, X1100, X1140

- Alert the surrounding people when operating in reverse



Hand Throttle Kit

D902 Engine K7591-99450 (V5241)

X900

D1105 Engine K7421-99450 (V5243)

X1120, X1100

- Hold engine speed at a constant RPM regardless of vehicle speed





A Full RAC Frame System

77700-V5012 (V5012)

X900, X1120, X1100

- Heavy-duty powder-coated steel construction
- Wide selection of easy to use compatible attachments
- Exterior mounted risers provide greater carrying capacity
- Works with or without cab
- RAC Structure weighs approx. 85lbs



B Long Handle Tool Carrier

77700-V5018 (V5018)

X900, X1120, X1100

- High-strength steel construction
- Each scabbard has seven handle slots
- Two Scabbards can be combined to hold tools in-line
- Designed to minimize reach-over when loading & unloading tools
- Requires Full RAC Frame System (77700-V5012)



C**Extender Basket**

77700-V5015 (V5015)

X900, X1120, X1100

- Large basket that can be positioned horizontally and stacked
- High-strength steel construction but light enough for carrying by hand
- Free large elastic cargo net included - 32" L x 14" W
- Dimensions - 46" W x 14" D x 3.75" H
- Weight Capacity 125lbs
- Requires Full RAC Frame System (77700-V5012)

**D****RTV String Trimmer Holder**

77700-V4419 (V4419)

X900, X1120, X1100

- High-strength steel forks over-molded with durable rubber
- Patented non-binding rubber fins cushion objects being carried
- Heavy-duty rubber straps secure items to forks
- Forks rotate 360 degrees and lock into place for multiple angles
- Forks adjust from 1.5" to 3.5" wide to hold a wide range of shapes & sizes
- Requires Full RAC Frame System (77700-V5012)

**E****Half Clip Basket**

77700-V5016 (V5016)

X900, X1120, X1100

- Shorter version of the Full Clip Basket for smaller loads
- Dimensions - 24.15"L x 12.5"W x 4.3"H
- Weight Capacity 75lbs
- Elastic cargo net included
- Requires Full RAC Frame System (77700-V5012)

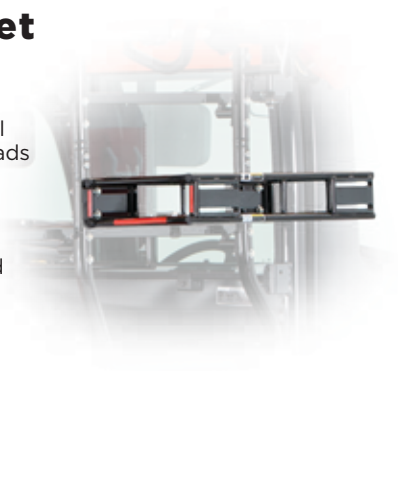
**RTV Backpack Blower Holder**

77700-V4421 (V4421)

X900, X1120, X1100

- Made specifically for STIHL® BR Series backpack blowers
- High-strength steel construction
- Integrated hose management system
- Multiple mounting locations inside and outside RAC Structure
- Requires Full RAC Frame System (77700-V5012)

**F****Full Clip Basket**

77700-V5017 (V5017)

X900, X1120, X1100

- High-strength steel construction but light enough to carry by hand
- Multiple mounting locations inside or outside RAC Structure
- Dimensions - 37.75"L x 12.5"W x 4.3"H
- Elastic cargo net included- 11"L x 14"W
- Weight Capacity 75lbs
- Requires Full RAC Frame System (77700-V5012)

**Cooler/Bucket Cruiser**

77700-V4422 (V4422)

X900, X1120, X1100

- High-strength steel construction
- Integrated straps with buckles adjust to a variety of container shapes/sizes
- Multiple mounting locations inside and outside RAC Structure
- Requires Full RAC Frame System (77700-V5012)



2 Front LED Work Light Kit

77700-VC5050 (VC5050)

X900, X1120, X1140

- Six high intensity LEDs on each light
- Illuminated, high quality rocker switch
- Sold in a pair (left & right)
- Only compatible with the "VC" cab components
- Requires Wire Harness (Multiple - 77700-VC5080) or (Single - 77700-VC5081)



Rear LED Work Light Kit

77700-VC5051A (VC5051A)

X900, X1120, X1140

- Six high intensity LEDs on each light
- Illuminated, high quality rocker switch
- Sold individually
- Only compatible with the "VC" cab components
- Requires Wire Harness (Multiple - 77700-VC5080) or (Single - 77700-VC5081)



Dome Light

77700-VC5053 (VC5053)

X900, X1120, X1140

- Built-in on/off rocker switch
- Bright 1-watt LED light
- Adjustable 40-degree swivel and spin
- Convenient for pre-dawn or working late into the night
- Only compatible with the "VC" cab components
- Requires Wire Harness (Multiple - 77700-VC5080) or (Single - 77700-VC5081)



Strobe Light

77700-VC5056 (VC5056)

X900, X1120, X1140

77700-VC5058 (VC5058)

X1100

- Amber beacon features 70 FPM pulse, 8 ash patterns
- Illuminated, high quality rocker switch
- Only compatible with the "VC" cab components
- Requires Wire Harness (Multiple - 77700-VC5080) or (Single - 77700-VC5081)



4-Way Strobe-type Flashers

77700-VC5057A (VC5057A)

X900, X1120, X1140

- Black and weatherproof housing for indoor or outdoor use
- 18 different flash patterns to choose from
- Only compatible with the "VC" cab components
- Requires Wire Harness (Multiple - 77700-VC5080) or (Single - 77700-VC5081)



Select either wiring harness setup below to power the 5 lights above individually or together.

Wire Harness - Multiple

77700-VC5080 (VC5080)

X900, X1120, X1140

- Includes painted switch panel for up to five additional accessory switches
- Panel plugs for un-used positions
- Six position fuse block with vinyl dust cover for circuit and fuse protection



Wire Harness - Single

77700-VC5081 (VC5081)

X900, X1120, X1140

- For single electrical accessory or light
- In-line fuse for circuit protection
- Automotive relay included

LIGHTS / ENGINE

LED Kits

Front LED Kit 77700-11811

X1100C

Rear LED Kit 77700-11812

X1100C

- Six high intensity LEDs
- Ideal for off-road driving only
- Measured lumen: 1,000 lm
- Multivolt 10-30V DC
- Mounting: upright or flush
- Dimensions: 1.8"W x 6.3"H x 2.5"D
2.4"W x 7.7"H x 1.8"D (flush)

NEW



Additional lighting options available with all the required included.

Halogen Front Work Lights

K7591-99620 (V5222)

X900, X1120

K7731-99620 (V5282)

X1100

- Halogen front work light kit includes 2 work lights
- For RTV-X1100, the lights mount to the top with everything necessary for installation
- For RTV-X900 and RTV-X1120, lights mount to the ROPS or Plastic Canopy (K7591-99390) with everything necessary for installation



Halogen Rear Work Light

K7591-99630 (V5223)

X900, X1120

K7731-99630 (V5283)

X1100

- Halogen rear work light kit includes 1 work light
- For RTV-X1100, the lights mount to the top with everything necessary for installation
- For RTV-X900 and RTV-X1120, lights mount to the ROPS or Plastic Canopy (K7591-99390) with everything necessary for installation



Hazard Light Kit

K7591-99610 (V5237)

X900, X1120, X1140

K7731-99610 (V5257)

X1100

- Includes two front hazard/indicator lamps and two rear combination hazard



Strobe Light Mounting Bracket

77700-V4284

X1100

- Sturdy 10GA cold-rolled steel for secure mounting
- Durable UV-resistant powder paint for long lasting durability



Block Heater

77700-06199

X900

70000-73595

X1120, X1100, X1140

- Makes starting in cold climates less demanding on the engine



Extended Oil Dipstick

D902 Engine K7591-99810 (V5202)

X900

D1105 Engine K7621-99810 (V5204A)

X900, X1120, X1140

- Check oil regularly and precisely without having to raise the dump bed



ELECTRIC POWERED IMPLEMENTS & ATTACHMENTS

72" General Duty Front Blade

V5008*

X900, X1120, X1100, X1140

- 72" wide general purpose snow blade with 19" moldboard height and 12 gauge moldboard thickness
- 64.5" plow width @ 30° max angle
- Electric lift with manual angle adjustment
- Recommend optional Hydraulic Angle Kit (V5007) to convert to hydraulic angle
- Requires Front Heavy Duty Strut Kit (K7591-99180) or Front Heavy Duty Spring Kit (K7591-99190)



HYDRAULIC POWERED IMPLEMENTS & ATTACHMENTS

72" XTRA Duty Front Blade

V5060*

X900, X1120, X1100, X1140

- 72" wide heavy duty snow blade with 23.5" moldboard height and 12 gauge moldboard thickness
- 64.5" plow width @ 30° max angle
- Includes self contained electro-hydraulics for lift and angle adjustment
- Requires Front Heavy Duty Strut Kit (K7591-99180) or Front Heavy Duty Spring Kit (K7591-99190)



72" Commercial Straight Blade

V5290*

X900, X1120, X1100

- 72" wide commercial snow blade with 21.75" moldboard height and 10 gauge moldboard thickness
- 62.4" plow width @ 30° max angle
- Hydraulic lift with down pressure and float
- Hydraulic angle adjustment with adjustable blade trip springs
- Recommend optional Markers (V5250)
- Requires Front Quick Hitch (V5289), Electro-Hydraulic Valve Kit (V5232), Auxiliary Hydraulic Pump (X900 - V5271) or (X1120/X1100 - V5272), & Front Heavy Duty Strut Kit (K7591-99180) or Front Heavy Duty Spring Kit (K7591-99190)



72" V-Plow Blade

V5291*

X900, X1120, X1100

- 72" wide V-Blade (straight) with moldboard height 19 1/8" @ center, 20 1/2" @ ends, and 3/8" moldboard thickness
- 66" V position width and 59" scoop position width
- Hydraulic lift with down pressure and float
- Hydraulic angle adjustment with built-in relief valves to protect against impact
- Trip cutting edges
- Recommend optional Markers (V5250) and Curb Guards (V5256)
- Requires Front Quick Hitch (V5289), Electro-Hydraulic Valve Kit (V5232) & (3rd function - V5233), Auxiliary Hydraulic Pump (X900 - V5271) or (X1120/X1100 - V5272), & Front Heavy Duty Strut Kit (K7591-99180) or Front Heavy Duty Spring Kit (K7591-99190)



60" Rotary Broom

V5260*

X900, X1120, X1100

- 60" wide rotary broom with 18" diameter poly brushes
- 50 1/2" width @ 25° max angle
- Reversible broom rotation
- Hydraulic lift and angle adjustment
- Recommend optional Markers (V5250)
- Requires Front Quick Hitch (V5289), Electro-Hydraulic Valve Kit (V5232) & (3rd function - V5233), Auxiliary Hydraulic Pump (X900 - V5271) or (X1120/X1100 - V5272), Hydraulic Oil Cooler (V5240), Hand Throttle Kit (V5245), & Front Heavy Duty Strut Kit (K7591-99180) or Front Heavy Duty Spring Kit (K7591-99190)



HYDRAULIC POWERED MOUNTING SYSTEM

Front Quick Hitch

V5289*

X900, X1120, X1100

- Required quick hitch system designed for 72" Commercial Straight Blade (V5290), 72" V-Plow Blade (V5291), and 60" Rotary Broom (V5260) for easy implement changes



Front Guard Adapter Kit

77700-V5255 (V5255)

X900, X1120, X1100

- Optional front guard adapter for Front Quick Hitch (V5289) to reinstall front guard when front quick hitch implements are put away for the season

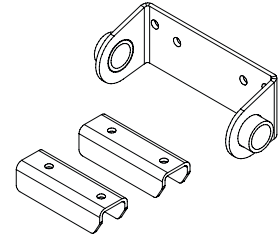

HYDRAULIC POWERED ATTACHMENTS

Hydraulic Angle Kit

V5007*

X900, X1120, X1100, X1140

- Optional hydraulic angle kit to upgrade 72" General Duty Front Blade (V5008) to hydraulic angle adjustment
- Requires Auxiliary Hydraulic Pump (X900 - V5271), (X1120/X1100 - V5272), or (X1140 - V5262) and Auxiliary Hydraulic Valve: One Valve (X900/X1120/X1100 - V5273), Two Valve (X900/X1120/X1100 - V5274), or One Valve (X1140 - V5263)

Auxiliary Hydraulic Valve Kit

One Valve V5273*

X900, X1120, X1100

One Valve V5263*

X1140

Two Valve V5274*

X900, X1120, X1100

- Required for Hydraulic Angle Kit (V5007) and aftermarket implements

Hydraulic Oil Cooler

V5240*

X900, X1120, X1100

- Required for 60" Rotary Broom (V5260)

Hand Throttle Kit

V5245*

X900, X1120, X1140

- Required for 60" Rotary Broom (V5260)

Markers

V5250*

X900, X1120, X1100

- Optional markers to increase visibility for 72" Commercial Straight Blade (V5290), 72" V-Plow Blade (V5291), or 60" Rotary Broom (V5260)

Auxiliary Hydraulic Pump

D902 Engine V5271*

X900

D1105 Engine V5272*

X1120, X1100

D1105 Engine V5262*

X1140

- Required for Hydraulic Angle Kit (V5007), hydraulic powered implements, and aftermarket implements

Electro-Hydraulic Valve Kit

Two Function V5232*

X900, X1120, X1100

3rd Function V5233*

X900, X1120, X1100

- Required for 72" Commercial Straight Blade (V5290), 72" V-Plow Blade (V5291), and 60" Rotary Broom (V5260)

Hydraulic Coupler Outlet

V5276*

X900, X1120, X1100, X1140

- Stationary applications only, optional coupler to power aftermarket implements
- Cannot be used to power hydraulic motor applications

Curb Guards for V-Blade

V5256*

X900, X1120, X1100

- Optional curb guards to protect the corners of 72" V-Plow Blade (V5291) from incidental curb damage

4 POINT K-CONNECT IMPLEMENTS

78" Straight Blade

V5294A*

X1120, X1100, X1140

- 78" wide K-connect snow blade with 24" moldboard height and 0.075" moldboard thickness
- 68" plow width @ 30° max angle covers the width of the RTV-X
- Hydraulic lift with down pressure and float
- Hydraulic angle adjustment with two spring trip protection
- Reinforced with 4 vertical ribs, 2 diagonal ribs, and C-channels
- New curvature allows for rolling of snow eliminating the need for a deflector and includes markers and skid shoes standard
- Recommend optional Curb Guards (V5281)
- Requires 4 Point K-Connect (V5293) and Front Heavy Duty Strut Kit (K7591-99180) or Front Heavy Duty Spring Kit (K7591-99190)
- Compatible with PTO Drive K-Connect (V5299)



78" V-Blade

V5295A*

X1120, X1100, X1140

- 78" wide K-connect V-blade (straight) with moldboard height 20" @ center, 25 3/4" @ ends, and 0.075" moldboard thickness
- 69 1/2" V position width and 66" scoop position width
- Hydraulic lift with down pressure and float
- Hydraulic angle adjustment with built-in relief valves to protect against impact
- Trip cutting edges
- Reinforced with 3 vertical ribs, 1 diagonal ribs, and C-channel on each wing
- New curvature allows for rolling of snow eliminating the need for a deflector and includes markers and skid shoes standard
- Recommend optional Curb Guards (V5281)
- Requires 4 Point K-Connect (V5293) and Front Heavy Duty Strut Kit (K7591-99180) or Front Heavy Duty Spring Kit (K7591-99190)
- Compatible with PTO Drive K-Connect (V5299)



4 POINT K-CONNECT MOUNTING SYSTEM & ATTACHMENTS

4 Point K-Connect

V5293*

X1120, X1100, X1140

- 4 point quick hitch system with a power unit to provide an independent 3 function hydraulic system
- Used to quick attached 78" Straight Blade (V5294A) or 78" V-Blade (V5295A)



4 Point Upgrade Kit

V5298*

X1120, X1100, X1140

- Add a brush bar and 2 rectangular LED worklights to the 4 Point K-Connect (V5293)
- Requires 4 Point K-Connect (V5293)



Front Guard Adapter Kit

77700-V5278 (V5278)

X1120, X1100, X1140

- Optional front guard adapter for 4 Point K-Connect (V5293) to reinstall front guard when front K-Connect implements are put away for the season

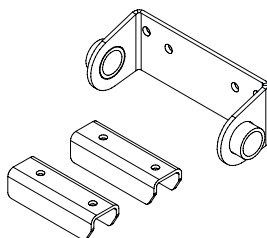

Rubber Cutting Edge

V5287*

X1120, X1100, X1140

- Optional rubber cutting edge for 78" Straight Blade (V5294A)

Plastic Cutting Edge

V5288*

X1120, X1100, X1140

- Optional plastic cutting edge for 78" Straight Blade (V5294A)

Plastic Cutting Edge

V5284*

X1120, X1100, X1140

- Optional plastic cutting edge for 78" V-Blade (V5295A)

Curb Guards

V5281*

X1120, X1100, X1140

- Optional curb guards to protect the corners of 78" Straight Blade (V5294A) and 78" V-Blade (V5295A) from incidental curb damage

Skid Shoes

V5285*

X1120, X1100, X1140

- Replacement skid shoes for 78" Straight Blade (V5294A) and 78" V-Blade (V5295A)

PTO DRIVE K-CONNECT IMPLEMENTS

66" Rotary Broom

V5266*

X1120, X1100

- 66" wide PTO driven rotary broom with 24" diameter poly brushes
- 59 1/2" width @ 25° max angle
- Hydraulic lift and angle adjustment with 8 1/2 degree oscillation
- Floating wheels and markers standard
- Requires 4 Point K-Connect (V5293), PTO Drive K-Connect (V5299), and Front Heavy Duty Strut Kit (K7591-99180) or Front Heavy Duty Spring Kit (K7591-99190)



66" Commercial Snowblower

V5296*

X1120, X1100

- 66" wide PTO driven 2-stage commercial snowblower with hydraulic chute rotation and deflection
- 16" fan with 4 blades
- Skid shoes and drift cutters are standard
- Requires 4 Point K-Connect (V5293), PTO Drive K-Connect (V5299), and Front Heavy Duty Strut Kit (K7591-99180) or Front Heavy Duty Spring Kit (K7591-99190)



PTO DRIVE K-CONNECT MOUNTING SYSTEM & ATTACHMENT

PTO Drive K-Connect

V5299A*

X1120, X1100

- Used in conjunction with 4 Point K-Connect (V5293) to operate 66" Rotary Broom (V5266) or 66" Commercial Snowblower (V5296)
- For RTV-X1120, requires Water Pump Pulley (16241-74250) and Engine Fan Belt (1E270-97010)
- Requires 4 Point K-Connect (V5293)



50/50 Poly & Steel Brush Kit

V5269*

X1120, X1100

- Optional 24" diameter 50/50 poly and steel brush kit for 66" Rotary Broom (V5266)

Plastic Cutting Edge with Skid Shoes

V5297*

X1120, X1100

- Optional plastic cutting edge and skid shoes for 66" Commercial Snowblower(V5296)



Rock Salt Spreader

V5002-A*

X900, X1120, X1100

- Ideal for winter applications with 3 cubic feet capacity (240 lbs) and spreading width up to 25 ft
- Electric powered motor and transmission controlled by a variable speed weatherproof controller
- Heavy duty poly hopper construction
- Top screen and fitted cover included



Tailgate Spreader

V5003-A*

X900, X1120, X1100

- Ideal for year round use with 3 cubic feet capacity (240 lbs) and spreading width up to 20 ft
- Easy-to-calibrate for various materials (e.g. seed, fertilizer, bagged ice melt, and more)
- Electric powered motor and transmission controlled by a variable speed weatherproof controller
- Heavy duty poly hopper construction
- Top screen and fitted cover included



Cargo Box Spreader

V5005*

X900, X1120, X1100

- 11 cubic feet capacity (800 lbs) and spreading width up to 30 ft
- Electric powered motor and transmission with a dual controller for independent material and spread width control
- Heavy duty poly hopper construction
- Top screen, fitted cover, and heavy duty vibrator included



Flow Control Tube

V4407*

X900, X1120, X1100

- Optional stainless adjustable flow regulator helps prevent leaking issues when handling fine pellet and flake materials
- Requires Cargo Box Spreader (V5005)



Spreading Materials	V5002-A	V5003-A	V5005
Bagged Rock Salt	X		X
Bagged Ice Melters		X	X (w/ V4407)
Calcium Chloride Pellets		X	X (w/ V4407)
Calcium Flakes		X	X
Granular Fertilizer & Turf Care Materials		X	X (w/ V4407)
Bulk Rock Salt			X
50/50 Sand/Salt Mix			X

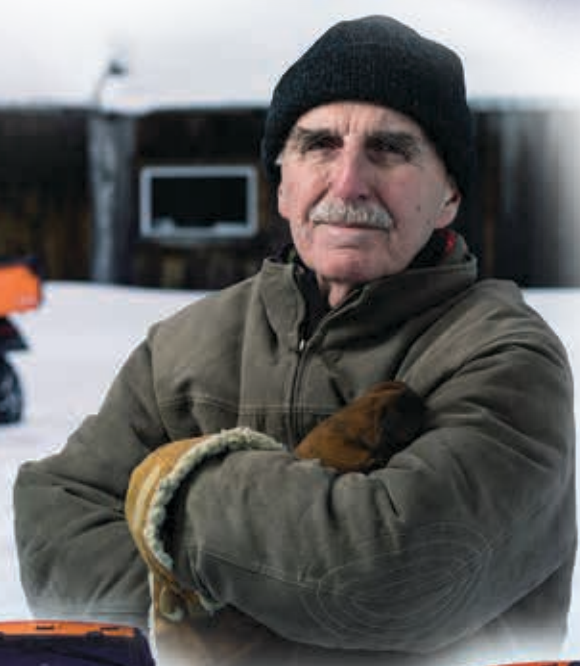

HDWS Tire & Wheel Assembly

K7591-19312 (ARTV5203)
X900, X1120, X1100, X1140

- Includes 1 OEM tire and steel wheel
- 25x10-12 6 ply tire
- HDWS tread design are non-directional



ATV Tire & Wheel Assembly

Left K7591-19112 (ARTV5201L)

Right K7591-19162 (ARTV5201R)

X900, X1120, X1100, X1140

- Includes 1 OEM tire and steel wheel
- 25x10-12 6 ply tire
- ATV tread design are directional (left or right)



TURF Tire & Wheel Assembly

K7591-19613 (ARTV5205)
X900, X1120, X1100

- Includes 1 OEM tire and steel wheel
- 25x12-12 6 ply tire
- TURF tread design are non-directional



Tire & Alloy Wheel Assembly

Black ATV Left K7591-99850 (ARTV5212L)

Black ATV Right K7591-99860 (ARTV5212R)

Black HDWS K7591-99800 (ARTV5214)

Silver ATV Left K7591-99830 (ARTV5211L)

Silver ATV Right K7591-99840 (ARTV5211R)

Silver HDWS K7591-99790 (ARTV5213)

X900, X1120, X1100, X1140

- Includes 1 OEM tire and alloy wheel
- 25x10-12 6-ply tire
- ATV tread design are directional (left or right)
- HDWS tread design are non-directional
- Requires Alloy Wheel Hardware Kit (black - K7591-99140) or (silver - K7591-99170)



RTV ACCESSORIES

Cargo Net

77700-08978

- 34" x 34" — stretches to 60" x 60"
- Heavy duty plastic hooks prevent scratching
- Finger holes in hooks for safety and easy hook up
- Weather resistant
- Secures odd, bulky shapes
- Adjustable hooks
- Fits most UTV/RTV Bed Boxes

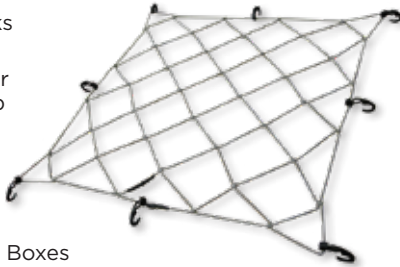

Fire Extinguisher Mount

77700-10709

RTV-X900, RTV-X1120,
RTV-X1140, RTV-XG850

- Secures fire extinguishers up to 3.5" in diameter
- Universal design mounts to round tube roll cages up to 2.25"
- Patented low-profile mounting
- Adjustable clamps secure most fire extinguishers
- Fire extinguisher not included



Dust Masks

Universal Safety 77700-10710

XL Safety 77700-10711

Camo Safety 77700-10712

Neoprene Dust Mask 77700-10713

Red Bandana Style 77700-10714

Black Bandana Style 77700-10715

- Washable and reusable
- Improved design provides maximum comfort
- No replacement filters needed
- Compatible with open and closed face helmets and goggles



Safety Dust Mask



Neoprene Dust Mask

GearTie® Loopable MEGA Reusable Twist Tie - Black 32"

77700-10782

- Allows you to tie and secure a long handle tool and countless other items



RTV Tow Strap

77700-08977

- 1-1/4" X 12' tow strap with loops and shackle
- 5,000 lbs. break strength
- Forged shackle
- Reinforced attachment loops



ShockStrap® Load-Absorbing Ratchet Straps

9' x 2" 77700-10680

18' x 2" 77700-10681

- Dependable - a ShockStrap® provides superior shock absorption without coming loose—keeps tension on the strap
- Safety Strap - a backup strap in case the ShockStrap® is compromised
- Durable - made from our proprietary formula that is not affected by most chemicals, sunlight, oil, salt water, fungus or moisture
- Rust Resistant - hooks and buckle are yellow zinc coated, which lasts 8 to 10 times longer than chrome plating
- Soft Loop - flexibility to always find a way to secure your load

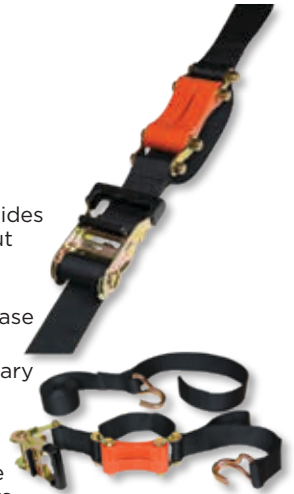

Work Gear Bag

77700-10694

X900, X1120, X1100,
X1140

- Made from heavy duty, ballistic nylon
- Easily and quickly attaches to your Kubota RTV or Kubota stand-on mower
- Includes strap kit to attach to your RopsRackPack® and buckles for attaching to your Ultimate Rack
- Gear Bag is 18" long x 4" wide x 11" tall



10" S-Biner® Dual Carabiner

77700-10783

- Allows you to hang your trimmer, leaf blower and other large items



RTV400/RTV500 ACCESSORIES & IMPLEMENT FITMENT GUIDE

Cab Components		RTV400	RTV500
77700-V4409 (V4409)	Poly Cab Enclosure	X	
77700-V4310A (V4310A)	Poly Cab Component Mounting Kit	X	X
77700-V4368 (V4368)	Poly Windshield	X	X
77700-V4312 (V4312)	Plastic Canopy	X	X
77700-V4428 (V4428)	Acrylic Rear Panel	X	X
77700-V4429 (V4429)	Plastic Door Kit	X	
77700-V4367 (V4367)	Wiper Kit	X	X
77700-V4430 (V4430)	Vinyl Cab Enclosure	X	
77700-V4363 (V4363)	Vinyl Cab Component Mounting Kit	X	X
77700-V4365 (V4365)	Poly Windshield	X	X
77700-V4364 (V4364)	Metal Canopy	X	X
K7311-99280 (V4316)	Upper Glass Windshield	X	X
K7311-99290 (V4315)	Lower Poly Windshield	X	X
K7311-99390 (V4321)	Plastic Canopy	X	X
K7311-99540 (V4350)	Rear Cargo Screen (Gray)	X	X
K7311-99590	Rear Cargo Screen (Black)	X	X
Winch / Guard / Bed Lift			
77700-V4380 (V4380)	Heavy Duty Winch - 2500 lb	X	X
K7311-97312	Front Winch Mount Kit	X	X
K7311-99210 (V4325)	Silver Front Grill Guard		X
77700-V4326 (V4326)	Electric Bed Lift	X	X
77700-V4349 (V4349)	2" Trailer Hitch Ball Mount		X
Cab Accessories			
K7211-99640 (V4336)	Backup Beeper	X	
K7311-99640 (V4332)	Backup Beeper		X
K7211-99650 (V4338)	Speedometer	X	
K7311-99650 (V4333)	Speedometer		X
K7501-99550 (V4231XT)	Headrest (Gray)	X	X
K7311-99530 (V4341)	Headrest Stay Kit (Gray)	X	X
K7311-99580 (V4341A)	Headrest Stay Kit (Black)	X	X
77700-V4358 (V4358)	Side Mirror - ROPS	X	X
77700-V5059 (V5059)	Side Mirror - Cab	X	

Storage		RTV400	RTV500
K7311-99560 (V4335)	Front Accessory Box		X
K7211-99200 (V4352)	Cargo Box Mat	X	X
K7311-99200 (V4351)	Cargo Box Mat		X
77700-V4381 (V4381)	RTV Storage Cover	X	X
77700-V4384 (V4384)	ROPS Storage Organizer	X	X
Lights			
77700-V4339 (V4339)	Front/Rear Worklight Kit	X	X
K7311-99620 (V4322A)	Front Worklight Kit	X	X
K7311-99630 (V4323A)	Rear Worklight (1)	X	X
77700-V4318 (V4318)	Strobe Light Kit	X	X
K7311-99610 (V4337A)	Turn Signal/Hazard Light Kit	X	X
Snow Removal			
V4308A*	60" Front Blade	X	X
V4305*	Standard Cutting Edge	X	X
V4306*	Heavy Duty Cutting Edge	X	X
V4307*	Snow Deflector	X	X
Tires & Wheels			
K7311-19310 (ARTV4303)	HDWS Tire & Wheel Assembly - Front Tire	X	X
K7311-19410 (ARTV4304)	HDWS Tire & Wheel Assembly - Rear Tire	X	X
K7311-19110 (ARTV4301)	ATV Tire & Wheel Assembly - Front Left	X	X
K7311-19160 (ARTV4301)	ATV Tire & Wheel Assembly - Front Right	X	X
K7311-19210 (ARTV4302)	ATV Tire & Wheel Assembly - Rear Left	X	X
K7311-19260 (ARTV4302)	ATV Tire & Wheel Assembly - Rear Right	X	X

*Order through Wholegoods

RTV-X SERIES & RTV-XG850 SIDEKICK ACCESSORIES & IMPLEMENT FITMENT GUIDE

Cab Components		RTV-X900	RTV-X1120	RTV-X1100	RTV-X1140	RTV-XG850
77700-VC5023 (VC5023)	Poly Windshield	X	X		X	
77700-VC5020 (VC5020)	Laminated Glass Windshield (AS1)	X	X		X	
77700-VC5025 (VC5025)	Tempered Glass Windshield (AS2)	X			X	
77700-VC5030 (VC5030)	Windshield Wiper Kit	X	X		X	
K7591-99290 (V5258)	Poly Windshield (Clear)	X	X			
K7591-99260 (V5259)	Poly Windshield (Tinted)	X	X			
77700-V5027 (V5027)	Acrylic Windshield (Clear)	X	X		X	
77700-V5028 (V5028)	Acrylic Windshield (Tinted)	X	X		X	
77700-VP0804A	Poly WS					X
77700-VP0805	Poly Flip WS					X
77700-VP0802	Glass WS					X
77700-VP0817	Wiper Kit					X
77700-VP0818	Washer Kit					X
77700-VC5000 (VC5000)	Metal FOPS Canopy (Black)	X	X			
77700-VC5001 (VC5001)	Metal FOPS Canopy (Orange)	X	X			
77700-VC5044 (VC5044)	Metal FOPS Canopy (Black)				X	
77700-VC5011 (VC5011)	Plastic Canopy (Black)	X	X			
77700-VC5043 (VC5043)	Plastic Canopy (Black)				X	
K7591-99390 (V5221)	Plastic Canopy (Black)	X	X			
77700-VP0801A	Premium Roof					X
77700-VP0897	Premium Audio System					X
K7711-63160	Antenna					X
77700-VP0800	Sport Roof					X
77700-VP0807	Sport Roof Seal Panel Kit					X
77700-VC5040 (VC5040)	Glass Rear Panel	X	X			
K7711-99280 (V4258)	Rear Screen (Gray)			X		
K7731-99280 (V4258A)	Rear Screen (Black)			X		
77700-VP0806	Poly Rear Panel w/ Vent					X
77700-VP0803	Glass Rear Panel					X
77700-VC5090 (VC5090)	Metal Door Set (Black)	X	X			
77700-VC5091 (VC5091)	Metal Door Set (Orange)	X	X			
77700-VC5095 (VC5095)	Vinyl Door Set	X	X			

Cab Components		RTV-X900	RTV-X1120	RTV-X1100	RTV-X1140	RTV-XG850
77700-VC5045 (VC5045)	4 Metal Door Set w/ Rear Panel				X	
77700-VP0810	Door Set					X
77700-VP0820	Door Insert Kit - Orange					X
77700-VP0821	Door Insert Kit - Camo					X
77700-VP0822	Door Insert Kit - Green					X
77700-VP0823	Door Insert Kit - Black					X
77700-VC5046 (VC5046)	Mid Panel - Steel with Sliding Window				X	
77700-VC5047 (VC5047)	Mid Panel- Vinyl				X	
K7591-99190 (V5218)	Front Heavy Duty Spring Kit	X	X	Standard	Standard	
K7591-99180 (V5219)	Front Heavy Load Spring and Damper Assy Kit	X	X	Standard	Standard	X
77700-VC5076 (VC5076)	Side Mirror Kit - Cab (2)	X	X		X	
77700-V4358 (V4358)	Side Mirror Kit - ROPS (1)	X	X		X	X
77700-V5059 (V5059)	Side Mirror Kit - Cab (1)			X		
77700-VP0815	Side Mirror Kit - Cab (2)					X
77700-04753	Jensen Radio, AM/FM/WB/AUX			X		
77700-04754	Jensen Radio, AM/FM/WB/AUX/USB/IPOD/SAT			X		
77700-04755	Jensen Radio, AM/FM/WB/AUX/USB/IPOD/SAT/CD/BT			X		
77700-VC5083A (VC5083A)	Heater Kit	X	X		X	
77700-V5247	Heater Kit					X
77700-VP0808	Under hood Seal Kit					X
77700-VP0819A	2" ROPS Quick Clamp	X	X	X		X
Winch						
77700-V5244 (V5244)	Winch Kit (4000 lb)	X	X	X	X	X
77700-08690 (V5253)	Winch Kit (4000 lb) w/ Synthetic Rope	X	X	X	X	X
Hitch & Bed Lift						
77700-V5200 (V5200)	Trailer Hitch Ball Mount Kit (for front or rear 2" receiver)	X	X	X	X	
K7591-99320 (V5242)	Hydraulic Bed Lift	X	X	Standard	Standard	
K7811-99670	Electric Over Hydraulic Bed Lift					X

RTV-X Series & RTV-XG850 SIDEKICK Accessories & Implement Fitment Guide

Guards		RTV-X900	RTV-X1120	RTV-X1100	RTV-X1140	RTV-XG850
K7591-97200	General Purpose Front Guard (Gray)	X				
K7591-97900	General Purpose Front Guard (Black)	X	X			X
K7591-97210	Worksite Front Guard (Gray)	X			X	
K7591-97910	Worksite Front Guard (Black)	X	X		X	
K7421-97200	Deluxe Front Guard (Gray)		X	X	X	
K7421-97900	Deluxe Front Guard (Black)		X	X	X	
K7811-97200	RTV-XG850 Front Guard					X
K7811-99220	Plastic Bumper					X
K7811-99240	Front Under Guard					X
K7811-99230	Bush Guard					X
K7591-99660 (V5227)	Tail Lamp Guard Kit	X	X	X	X	
K7811-99660	Tail Lamp Guards					X
K7811-99250	Rear Bumper					X
K7591-99150 (V5238)	CV Joint Guard - Front	X	X	X	X	
K7591-99160 (V5239)	CV Joint Guard - Rear	X	X	X	X	
K7811-99150	A-Arm Guards - Front					X
K7811-99160	A-Arm Guards - Rear					X
K7591-99520 (V5225)	Mud Guard - Front	X	X	X	X	X
K7591-99510 (V5226)	Mud Guard - Rear	X	X	X	X	
K7811-99510	Mud Guards - Rear					X
Cab Accessories						
77700-V4266 (V4266)	Interior Rearview Mirror	X	X		X	
77700-VP0816	Interior Rearview Mirror	X	X		X	X
K7731-99270 (V5286)	Sunvisor Kit (2)			X		
K7591-99570 (V5234)	Glove Box Cover Kit	X	X	Standard	Standard	
K7501-99550 (V4231XT)	Headrest (Gray)	X		Standard		
K7421-99550 (V5231)	Headrest (Black)		X			
K7811-99550	XG Headrest	X	X	X		X
K7591-99530 (V5230)	Headrest Bracket Kit (Gray)	X	X			
K7591-99540 (V5230A)	Headrest Bracket Kit (Black)	X	X			X
K7591-99640 (V5236)	Backup Alarm Kit	X	X	X	X	
K7811-99640	Reverse Alarm					X

Cab Accessories		RTV-X900	RTV-X1120	RTV-X1100	RTV-X1140	RTV-XG850
K7591-99450 (V5241)	Hand Throttle Kit - D902 Engine	X				
K7421-99450 (V5243)	Hand Throttle Kit - D1105 Engine		X	X		
77700-V0834	Soft Grip Handle	X	X		X	X
Storage						
77700-08760	Deluxe RTV Cargo Box	X	X	X	X	X
77700-V0838	Deluxe Cargo Box Mounting Kit	X	X	X	X	X
K7811-99560	Cargo Clamp (2)	X	X	X	X	X
77700-V0830	RTV Rubber Cargo Bed Mat	X	X	X		X
77700-V4382 (V4382)	Vehicle Storage Cover	X	X	X		
77700-V4383 (V4383)	Vehicle Storage Cover				X	
K7591-99580 (V5229)	Plastic Bed Liner	X	X	X		
K7811-99590	Cargo Bed Rail	X	X	X		X
K7811-99570	Bed Extender	X	X	X	X	X
77700-V0831	Rack Over Hood					X
77700-V5012 (V5012)	Full RAC Frame System	X	X	X		
77700-V5018 (V5018)	Long Handle Tool Carrier	X	X	X		
77700-V5015 (V5015)	Extender Basket	X	X	X		
77700-V4419 (V4419)	RTV String Trimmer Holder	X	X	X		
77700-V5016 (V5016)	Half Clip Basket	X	X	X		
77700-V4421 (V4421)	RTV Backpack Blower Holder	X	X	X		
77700-V5017 (V5017)	Full Clip Basket	X	X	X		
77700-V4422 (V4422)	Cooler/Bucket Cruiser	X	X	X		
Lights						
77700-VC5050 (VC5050)	Front LED Work Light Kit (2)	X	X		X	
77700-VC5051A (VC5051A)	Rear LED Work Light Kit (1)	X	X		X	
77700-VC5053 (VC5053)	Dome Light	X	X		X	
77700-VC5056 (VC5056)	Strobe Light LED	X	X		X	
77700-VC5058 (VC5058)	Strobe Light - LED with Mount Kit			X		
77700-VC5057A (VC5057A)	4-Way Strobe-type Flashers	X	X		X	
77700-VC5080 (VC5080)	Switch Panel/Wire Harness Kit for Multiple Accessories	X	X		X	
77700-VC5081 (VC5081)	Wire Harness Kit - for Single Accessory	X	X		X	

RTV-X Series & RTV-XG850 SIDEKICK Accessories & Implement Fitment Guide

Lights		RTV-X900	RTV-X1120	RTV-X1100	RTV-X1140	RTV-XG850
K7731-99620 (V5282)	Halogen Front Work Lights (2)			X		
K7731-99630 (V5283)	Halogen Rear Work Lights (1)			X		
K7591-99620 (V5222)	Halogen Front Work Lights (2)	X	X			
K7591-99630 (V5223)	Halogen Rear Work Lights (1)	X	X			
K7591-99610 (V5237)	Turn Signal / Hazard Light Kit	X	X		X	
K7731-99610 (V5257)	Turn Signal / Hazard Light Kit			X		
77700-VP0892	6" LED Worklights (1)					X
77700-VP0893	Front Worklights Mounting Kit					X
77700-VP0894	Rear Worklights Mounting Kit					X
77700-V0890	Sport Roof Worklights Supports					X
77700-VP0891	13.5" LED Light Bar					X
77700-VP0895	Light Bar Mounting Kit					X
77700-08687	Rotating Beacon					X
77700-08686	Strobe Light					X
77700-VP0896	Strobe Mounting Kit					X
77700-V0880	Switch Panel					X
77700-V0881	Accessory Wiring Harness					X
77700-V0882	ROPS Wiring Harness					X
K7811-99680	LED Headlight					X
K7811-99650	Front Worklights Kit - Grill Guard Mount					X
K7811-99610	Turn Signal / Hazard Light Kit					X
Snow Removal						
V5008*	72" General Duty Front Blade	X	X	X	X	X
V5060*	72" XTRA Duty Front Blade	X	X	X	X	
V5290*	72" Commercial Straight Blade	X	X	X		
V5291*	72" V-Plow Front Blade	X	X	X		
V5260*	60" Rotary Broom	X	X	X		
V5289*	Front Quick Hitch	X	X	X		
77700-V5255 (V5255)	Front Guard Adapter Kit	X	X	X		
V5007*	Hydraulic Angle Kit	X	X	X	X	
V5271*	Auxiliary Hydraulic Pump - D902	X				

Snow Removal		RTV-X900	RTV-X1120	RTV-X1100	RTV-X1140	RTV-XG850
V5272*	Auxiliary Hydraulic Pump - D1105		X	X		
V5262*	Auxiliary Hydraulic Pump - D1105				X	
V5263*	Auxiliary Hydraulic Valve (Single Valve)				X	
V5273*	Auxiliary Hydraulic Valve (Single Valve)	X	X	X		
V5274*	Auxiliary Hydraulic Valve (Double Valve)	X	X	X		
V5232*	Electro- Hydraulic Valve Kit (2 Function)	X	X	X		
V5233*	3rd Function Electro-Hydraulic Valve Upgrade Kit	X	X	X		
V5240*	Hydraulic Oil Cooler	X	X	X		
V5276*	Hydraulic Coupler Outlet	X	X	X	X	
V5245*	Hand Throttle Kit	X	X	X		
V5256*	Curb Guards for V-Blade - V5291	X	X	X		
V5250*	Markers	X	X	X		
V5295A*	K-Connect 78" V-Blade		X	X	X	
V5294A*	K-Connect 78" Straight Blade		X	X	X	
V5293*	4 Point K-Connect		X	X	X	
V5298*	4 Point Upgrade Kit		X	X	X	
77700-V5278 (V5278)	Front Guard Adapter Kit		X	X	X	
V5287*	Rubber Cutting Edge for Straight Blade -V5294A		X	X	X	
V5288*	Hard Plastic Cutting Edge Kit for Straight Blade -V5294A		X	X	X	
V5284*	Hard Plastic Cutting Edge Kit for V-Blade - V5295A		X	X	X	
V5281*	Curb Guards		X	X	X	
V5285*	Skid Shoes		X	X	X	
V5266*	K-Connect 66" Rotary Broom		X	X		
V5296*	K-Connect 66" Commercial Snowblower		X	X		
V5299*	PTO Drive K-Connect		X	X		
V5269*	50/50 Poly & Steel Brush Kit		X	X		

RTV-X Series & RTV-XG850 SIDEKICK Accessories & Implement Fitment Guide

Snow Removal		RTV-X900	RTV-X1120	RTV-X1100	RTV-X1140	RTV-XG850
V5297*	Plastic Cutting Edge with Skid Shoes		X	X		
77700-06199	Block Heater	X				
70000-73595	Block Heater		X	X	X	
K7591-99810 (V5202)	Extended Oil Dipstick - D902 Engine	X				
K7621-99810 (V5204A)	Extended Oil Dipstick - D1105 Engine		X	X	X	
Spreaders						
V5002-A*	Rock Salt Spreader	X	X	X		
V5003-A*	Tailgate Spreader	X	X	X		
V5005*	Cargo Box Spreader	X	X	X		
V4407*	Flow Control Tube	X	X	X		
Tires & Wheels						
K7591-19312 (ARTV5203)	HDWS Tire & Wheel Assembly	X	X	X	X	
K7591-19112 (ARTV5201L)	ATV Tire & Wheel Assembly - Left	X	X	X	X	
K7591-19162 (ARTV5201R)	ATV Tire & Wheel Assembly - Right	X	X	X	X	
K7591-19613 (ARTV5205)	Turf Tire & Wheel Assembly	X	X	X		
K7811-19410	HDWS Tire & Wheel Assembly					X
K7811-19210	ATV Tire & Wheel Assembly - Left					X
K7811-19260	ATV Tire & Wheel Assembly - Right					X
K7591-99800 (ARTV5214)	HDWS Tire & Black Alloy Wheel Assembly	X	X	X	X	X
K7591-99850 (ARTV5212L)	ATV Tire & Black Alloy Wheel Assembly - Left	X	X	X	X	X
K7591-99860 (ARTV5212R)	ATV Tire & Black Alloy Wheel Assembly - Right	X	X	X	X	X
K7591-99790 (ARTV5213)	HDWS Tire & Silver Alloy Wheel Assembly	X	X	X	X	X
K7591-99830 (ARTV5211L)	ATV Tire & Silver Alloy Wheel Assembly - Left	X	X	X	X	X
K7591-99840 (ARTV5211R)	ATV Tire & Silver Alloy Wheel Assembly - Right	X	X	X	X	X
K7811-99800	HDWS Tire & Green Alloy Wheel Assembly					X

Tires & Wheels		RTV-X900	RTV-X1120	RTV-X1100	RTV-X1140	RTV-XG850
K7811-99850	ATV Tire & Green Alloy Wheel Assembly - Left					X
K7811-99860	ATV Tire & Green Alloy Wheel Assembly - Right					X
K7591-99140 (V5203)	Hardware Kit - Alloy Wheel - Black	X	X	X	X	X
K7591-99170 (V5205)	Hardware Kit - Alloy Wheel - Silver	X	X	X	X	X

*Ordered through Wholegoods

RTV-X SERIES IMPLEMENTS

IMPLEMENT TYPE	SNOW PLOWS					
	General Duty	XTRA Duty	Commercial	Commercial V	K-Connect	K-Connect V
NAME						
PART #	V5008	V5060	V5290	V5291	V5294A	V5295A
CONSTRUCTION	12 Gauge	12 Gauge	10 Gauge	10 Gauge		14 Gauge
WEIGHT	238 lb	238 lb	255 lb		310 lb	380 lb
LENGTH	25.5"	25.5"			45.5"	42.5"
TOTAL WIDTH	72"	72"	72"	72"	78"	78"
WORKING WIDTH	72"	72"	72"	72"	78"	78"
WIDTH AT ANGLE	64.6"	64.6"	62.4"	62.4"	67.5"	68"
HEIGHT	19"	23"	24.2"	24.2"	24"	27.75"
LIFT HEIGHT	30.5"	30.5"			13.5"	12.75"
MAX ANGLE	28°	28°	30°	30°	30°	30°
MOUNT	A-Frame	A-Frame	Quick Hitch	Quick Hitch	K-Connect	K-Connect
LIFT SYSTEM	Electric	Electro-Hydraulic	Hydraulic	Hydraulic	Hydraulic	Hydraulic
ANGULATION SYSTEM	Manual	Electro-Hydraulic	Hydraulic	Hydraulic	Hydraulic	Hydraulic
Compatibility: RTV-X900	Yes	Yes	Yes	Yes	No	No
REQUIRED KITS	V5218 or V5219	V5218 or V5219	V5218 or V5219; V5289, V5271; V5232	V5218 or V5219; V5289, V5272; V5232; V5233		
KIT DESCRIPTION	HD Springs	HD Springs	HD Springs; Quick Hitch; Hydraulics	HD Springs; Quick Hitch; Hydraulics		
OPTIONAL KITS	V5271		V5273; V5274; V5250	V5273; V5274; V5256; V5250		
Compatibility: RTV-X1120	Yes		Yes	Yes	Yes	Yes
REQUIRED KITS	V5218 or V5219	V5218 or V5219	V5218 or V5219; V5289, V5272; V5232	V5218 or V5219; V5289, V5272; V5232; V5233	V5218 or V5219; V5293	V5218 or V5219; V5293
KIT DESCRIPTION	HD Springs	HD Springs	HD Springs; Quick Hitch; Hydraulics	HD Springs; Quick Hitch; Hydraulics	HD Springs; 4 Point Hitch; Power Unit	HD Springs; 4 Point Hitch; Power Unit
OPTIONAL KITS	V5272		V5273; V5274	V5273; V5274; V5256	V5278; V5287; V5288	V5278; V5284
Compatibility: RTV-X1100C	Yes	Yes	Yes	Yes	Yes	Yes
REQUIRED KITS			V5289, V5272; V5232	V5289, V5272; V5232; V5233	V5293	V5293
KIT DESCRIPTION			Quick Hitch; Hydraulics	Quick Hitch; Hydraulics	4 Point Hitch; Power Unit	4 Point Hitch; Power Unit
OPTIONAL KITS	V5272		V5273; V5274; V5250	V5273; V5274; V5256; V5250	V5278, V5287; V5288	V5278, V5284
Compatibility: RTV-X1140	Yes	Yes	No	No	No	No
OPTIONAL KITS	V5262; V5263					
Compatibility: RTV-XG850	Yes	No	No	No	No	No
REQUIRED KITS	V5219; K7591-97900					
KIT DESCRIPTION	HD Springs; General Purpose Front Guard					

IMPLEMENT TYPE	SPREADERS			BROOMS		SNOW BLOWER
	Salt	Seed	Sand/Salt	Hydraulic	K-Connect	K-Connect
NAME						
PART #	V5002-A	V5003-A	V5005	V5260	V5262	V5296
CONSTRUCTION	Poly	Poly	Poly	16 Gauge	16 Gauge	12 Gauge
WEIGHT	105 lb	130 lb	300 lb	200 lb	480 lb	340 lb
LENGTH	35"	35"	77"	36.375"	47.5"	30"
TOTAL WIDTH	30"	30"	48.5"	75.375"	76.75"	67"
WORKING WIDTH	20"	20"	30"	60"	65.5"	66"
WIDTH AT ANGLE				50.5"	59.5"	
HEIGHT	32"	30"	27"	19.75"	25"	45"
WORKING HEIGHT				18"	24"	20"
LIFT HEIGHT					7.375"	18.5°
MAX ANGLE				25°	25°	
MOUNT	Hitch	Hitch	Cargo Bed	Quick Hitch	K-Connect	K-Connect
LIFT SYSTEM				Hydraulic	Hydraulic	Hydraulic
ANGULATION SYSTEM				Hydraulic	Hydraulic	
DRIVE SYSTEM	Electric	Electric	Electric	Hydraulic	Front PTO	Front PTO
SPEED	Variable	Variable	Variable		243 RPM	Auger 155
CAPACITY	3 ft ³	3 ft ³	11 ft ³			
Compatibility: RTV-X900	Yes	Yes	Yes	Yes	No	No
REQUIRED KITS				V5218 or V5219; V5289, V5271; V5232; V5233; V5240; V5241		
KIT DESCRIPTION				HD Springs; Quick Hitch; Hydraulics; Oil Cooler		
OPTIONAL KITS			V4407	V5273; V5274; V5250		
Compatibility: RTV-X1120	Yes	Yes	Yes	Yes	Yes	Yes
REQUIRED KITS				V5218 or V5219; V5289, V5272; V5232; V5233; V5240; V5245	V5218 or V5219; V5293; V5299	V5218 or V5219; V5293; V5299
KIT DESCRIPTION				HD Springs; Quick Hitch; Hydraulics; Oil Cooler	HD Springs; 4 Point Hitch; Power Unit; K-Connect PTO	HD Springs; 4 Point Hitch; Power Unit; K-Connect PTO
OPTIONAL KITS			V4407	V5273; V5274;	V5278; V5298	V5278; V5298 ;V5285
Compatibility: RTV-X1100C	Yes	Yes	Yes	Yes	Yes	Yes
REQUIRED KITS				V5289; V5272; V5232; V5233; V5240; V5245	V5293; V5299	V5293; V5299
KIT DESCRIPTION				Quick Hitch; Hydraulics; Oil Cooler	4 Point Hitch; Power Unit; K-Connect PTO	4 Point Hitch; Power Unit; K-Connect PTO
OPTIONAL KITS			V4407	V5273; V5274; V5250	V5278; V5298	V5278; V5298; V5285
Compatibility: RTV-X1140	No	No	No	No	No	No

RTV MODEL FEATURES

MODEL	TRIM / COLOR	SERIES	ATV TIRE	ATV ALLOY WHEELS	HEAVY-DUTY WORK SITE TIRE	HDWS ALLOY WHEELS	TURF TIRE	GENERAL PURPOSE	WORK SITE HYDRAULIC BED LIFT	SPRAY-ON BED LINER	DELUXE MODEL	CALIFORNIA MODEL
Gas Models RTV400Ci												
RTV400Ci-H	Orange	Mid Chassis: Single -Cylinder, Gas, 15.8 hp, Two-Seater			X							
RTV400Ci-A	Orange		X									
RTV400CiR-H	Camo				X							
RTV400CiR-A	Camo		X									
Gas Models RTV500												
RTV500-H	Orange	Mid Chassis: Twin -Cylinder, Gas, 15.8 hp, Two-Seater			X							
RTV500-A	Orange		X									
RTV500R-H	Camo				X							
RTV500R-A	Camo		X									
Gas Models RTV-XG850												
RTV-XG850G-A	Orange	Large Chassis: Dual OHC Twin, Gas, 48.3 hp, Two-Seater	X					X				
RTV-XG850EVG-A	Orange		X					X				X
RTV-XG850W-A	Orange		X						X*			
RTV-XG850EVW-A	Orange		X						X*			X
RTV-XG850WL-H	Orange				X				X*	X		
RTV-XG850EVL-H	Orange				X				X*	X		X
RTV-XG850WGL-A	Green		X						X*	X		
RTV-XG850EVWGL-A	Green		X						X*	X		X
RTV-XG850RL-A	Camo		X						X*	X		
RTV-XG850EVRL-A	Camo		X						X*	X		X
RTV-XG850SL-AS	Black		X	X					X*	X		
RTV-XG850EVSL-AS	Black		X	X					X*	X		X
Diesel Models RTV-X900												
RTV-X900G-A	Orange	Large Chassis: 3 -Cylinder, Liquid Cooled, Diesel, 21.6 hp, Two-Seater	X					X				
RTV-X900G-H	Orange				X				X			
RTV-X900W-A	Orange		X							X		
RTV-X900W-H	Orange				X					X		
RTV-X900WL-A	Orange		X							X	X	
RTV-X900WL-H	Orange				X					X	X	
RTV-X900R-A	Camo		X									
RTV-X900RL-A	Camo		X								X	

MODEL	TRIM / COLOR	SERIES	ATV TIRE	ATV ALLOY WHEELS	HEAVY-DUTY WORK SITE TIRE	HDWS ALLOY WHEELS	TURF TIRE	GENERAL PURPOSE	WORK SITE HYDRAULIC BED LIFT	SPRAY-ON BED LINER	DELUXE MODEL	CALIFORNIA MODEL
Diesel Models RTV-X1120												
RTV-X1120G-A	Orange	Large Chassis: 3-Cylinder, Liquid Cooled, Diesel, 24.8 hp, Two-Seater	X					X				
RTV-X1120G-H	Orange				X			X				
RTV-X1120W-A	Orange		X						X			
RTV-X1120W-H	Orange				X				X			
RTV-X1120WL-A	Orange		X						X	X		
RTV-X1120WL-H	Orange				X				X	X		
RTV-X1120R-A	Camo		X						X			
RTV-X1120RL-A	Camo		X						X	X		
RTV-X1120DRL-AS	Camo			X					X	X	X	
RTV-X1120DWL-AS	Orange			X					X	X	X	
RTV-X1120DWL-HS	Orange					X			X	X	X	
Diesel Models RTV-X1100C												
RTV-X1100CW-A	Orange	Large Chassis Cab w/ HVAC 3-Cylinder, Liquid Cooled, Diesel, 24.8 hp, Two-Seater	X						X			
RTV-X1100CW-H	Orange				X				X			
RTV-X1100CW-T	Orange						X		X			
RTV-X1100CWL-A	Orange				X				X	X		
RTV-X1100CWL-H	Orange				X				X	X		
RTV-X1100CWL-AS	Orange		X						X	X		
RTV-X1100CWL-HS	Orange					X			X	X		
RTV-X1100CR-A	Camo		X						X			
RTV-X1100CR-H	Camo				X				X			
RTV-X1100CRL-A	Camo		X						X	X		
RTV-X1100CRL-H	Camo				X				X	X		
Diesel Models RTV-X1140												
RTV-X1140W-A	Orange	Convertible Chassis 3-Cylinder, Liquid Cooled, Diesel, 24.8 hp, Converts from Two-Seater to Four-Seater in under a minute	X						X			
RTV-X1140W-H	Orange				X				X			
RTV-X1140WL-A	Orange		X						X	X		
RTV-X1140WL-H	Orange				X				X	X		
RTV-X1140WL-AS	Orange			X					X	X		
RTV-X1140WL-HS	Orange					X			X	X		
RTV-X1140R-A	Camo		X									
RTV-X1140R-H	Camo				X							
RTV-X1140RL-A	Camo		X							X		
RTV-X1140RL-H	Camo				X					X		



Don't settle for less.
KEEP IT KUBOTA!



www.KubotaUSA.com

© 2020 Kubota Tractor Corporation.
Printed in the USA 08/2020.
77700-10102

Kubota Tractor Corporation reserves the right to change the stated specifications without notice. The catalog is for descriptive purposes only and does not provide any express or implied warranty of any nature, including any warranty of merchantability or for a particular purpose. For complete operational information, the operator's manual should be consulted. Kubota Tractor Corporation supplies products and services to United States residents only. For information regarding Kubota products or services outside the United States, see Kubota Corporation's global web site.